

# CRICKET - 1116

ULTRA COMPACT - 1000/1200 W TUNGSTEN



- **Type:** Followspot
- **Source:** 1000/1200 W Tungsten - Low noise fan
- **Optics:** 10.5° to 22.5° zoom

Followspot

## Anything else just isn't cricket!

The smallest of the followspot range with the optical excellence of its larger counterparts. Cricket's ultra compact dimensions and low power consumption make it the perfect introduction to Robert Juliat for discerning schools, amateur dramatics and smaller venues.

### Features

- **Fully closing iris:** removable for fast, easy replacement
- **Universal gobo holder:** "A" size glass and metal gobo
- **Internal glass filter holder:** long term use of durable coloured, dichroic or textured glass
- **Colour changer:** 6-way, 'push/pull' colour changer system for simultaneous use of multiple filters
- **Easy focus reference:** graduated scale on side of the unit; fast and easy refocusing

### Optical

- **SX optical system:** double condenser optics for exceptional optical quality
- **Variable zoom optics:** sharp focus at every beam angle. Independent control of image size and focus.

### Construction

- **Made in France :** fully manufactured in Robert Juliat premises retaining complete control over all aspects of quality
- **Bodywork:** strong sheet metal construction for durability
- **Moving parts:** smooth at all times, even when hot
- **Captive knobs and handles:** additional security when working at height or in transit
- **Easy access to all parts:** easy cleaning, re-lamping and maintenance

Picture:1116A

DSEN091\_1116 - 13/09/2021

Robert Juliat reserves the right to change or alter any of the items detailed on this page, to increase or improve manufacturing techniques without prior notice.

Robert Juliat S.A.S., 32 rue de Beaumont, 60530 Fresnoy-en-Thelle - France  
Telephone : +33 (0)3 44 26 51 89 - fax : +33 (0)3 44 26 90 79 - info@robertjuliat.fr  
www.robertjuliat.com



ROBERT JULIAT

## Source



- **Lamp type:** Tungsten
- **Socket:** G22

Admissible lamps	Power *	Lumen output*	Colour temperature*	Life*
LIF: CP71/CP40 - ANSI: FKJ	1 000 W	26 000 lm	3200K	200 h
LIF: CP93	1 200 W	30 000 lm	3200K	200 h

(\*) manufacturer's data

## Optics

### Characteristics

- **Type:** Zoom
- **Beam range:** 10.5° to 22.5°
- **Focal length:** 189 - 408 mm

### Gel filter

- **Shape:** Circle
- **Standard size:** 165 mm (6.5 in)

### Gobo

- **Size:** A
- **Material:** Metal  
Glass



## Photometrics

with LIF: CP93 source

### • Optics @ 10.5°

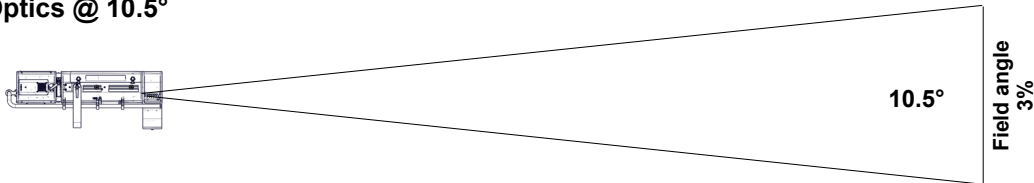

**Beam intensity**  
344 000 cd

<b>Distance</b>	5 m	10 m	15 m	20 m	25 m	30 m
<b>Diameter</b>	0.9 m	1.8 m	2.8 m	3.7 m	4.6 m	5.5 m
<b>Illumination</b>	14 000 lux	3 450 lux	1 550 lux	870 lux	560 lux	390 lux
<b>Distance</b>	15 ft	35 ft	50 ft	65 ft	80 ft	100 ft
<b>Diameter</b>	2.8 ft	6.4 ft	9.2 ft	11.9 ft	14.7 ft	18.4 ft
<b>Illumination</b>	1 550 fc	290 fc	140 fc	85 fc	55 fc	35 fc

### • Optics @ 22.5°

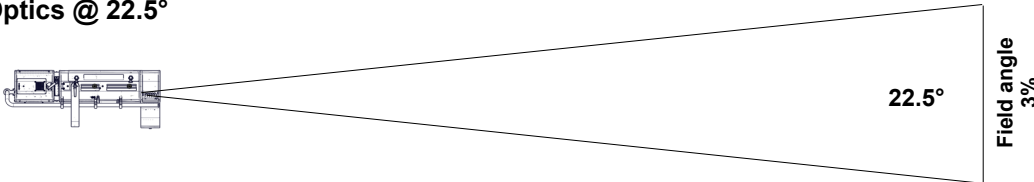

**Beam intensity**  
17 500 cd

<b>Distance</b>	5 m	10 m	15 m	20 m	25 m	30 m
<b>Diameter</b>	2 m	4 m	6 m	8 m	9.9 m	11.9 m
<b>Illumination</b>	710 lux	180 lux	80 lux	44 lux	29 lux	20 lux
<b>Distance</b>	15 ft	35 ft	50 ft	65 ft	80 ft	100 ft
<b>Diameter</b>	6 ft	13.9 ft	19.9 ft	25.9 ft	31.8 ft	39.8 ft
<b>Illumination</b>	80 fc	15 fc	8 fc	5 fc	3 fc	2 fc

## Dimensions and weight

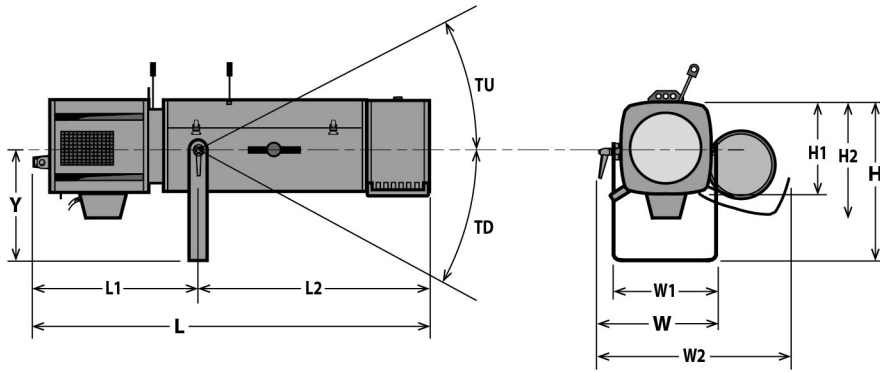

**Weight:** 16 kg (35.2 lbs)

Height	Length	Width	Yoke	Tilt
H= 390 mm (15.4 in)	L= 920 mm (36.2 in)	W= 330 mm (13 in)	Y= 283 mm (11.1 in)	TU= 45°
H1= 208 mm (8.2 in)	L1= 350 mm (13.8 in)	W1= 208 mm (8.2 in)		TD= 45°
H2= 265 mm (10.4 in)	L2= 570 mm (22.4 in)	W2= 490 mm (19.3 in)		

## Shipping

- **Weight :** 18.8 kg (41.4 lbs)
- **Volume :** .16 m<sup>3</sup> (5.65 ft<sup>3</sup>)

## Installation

- **Minimum distance to illuminated surface:** 2.5 m ( 8.2 ft )
- **Operating position:**

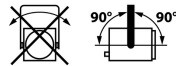

## Warranty

- **Fixture: 2 years**  
See General Sales Condition on website

## Approvals



## Construction

- **Housing:** Steel sheet - Aluminium
- **Colour:** Black
- **Cooling:** Low noise fan
- **Maximum ambient temperature (Ta):** 40°C (104°F)
- **Maximum case temperature (Tc):** 260°C (500°F)
- **Total heat dissipation:** 3 413 BTU/h
- **Ingress Protection (IP) rating:** IP20

## Electrical compatibility

- 230/240 V - 50 Hz
- ~~115/120 V - 60 Hz~~

## Power input



- **Type:** attached power cord
- **Cable:** H07RNF 3G1.5
- **Length:** 3 m (9.8 ft)
- **Power connector:** CEE 7/7 (2P+E NF/Schuko)



## Power consumption

Voltage	Frequency	Current	Power
230 V	50 Hz	5 A	1000 W
230 V	50 Hz	6 A	1200 W















## Model





<b>1116</b>	1000/1200 W Tungsten Followspot - G22 socket - 1116 Cricket - 10.5/22.5°
-------------	--

## Options

<b>PCP1716A</b>	16A blue 2P+E 6h IEC60309 power connector	
<b>FC1124</b>	Flight-case for Ultra Compact range / GT stand - Dim: 1210x600x560mm - Weight: 35 Kg	

## Accessories

<b>IS750</b>	Full closing iris with holder - Poids: 0.35 Kg <b>1 included</b>	
<b>PF1114</b>	Ø165 mm metal filter holder <b>6 included</b>	
<b>SGUX</b>	Universal "A" size gobo-holder (metal, glass, frosted glass) <b>1 included</b>	
<b>M165TP</b>	6 ways "push/pull" colour changer - Poids: 2.09 Kg <b>1 included</b>	
<b>CP71/CP40</b>	CP71/CP40 - G22 1000W 230V 200h 3200K lamp	
<b>CP93</b>	CP93 - G22 1200W 230V 200h 3200K lamp	
<b>GT1000</b>	Tripod stand - SWL: 40 Kg - max. height: 1550 mm - Poids: 9.27 Kg	
<b>GT800</b>	Tripod stand - SWL: 40 Kg - max. height: 1550 mm - Poids: 7.98 Kg	
<b>T1000</b>	TV spigot with followspots swivel head - Poids: 1.82 Kg	
<b>T4000</b>	Followspot mount for Ø50mm pipe (suspension or overhead) - SWL= 100 Kg - Poids: 4.88 Kg	
<b>CAV600A</b>	Double slot front cassette for 180x180mm accessories - Poids: 0.43 Kg	
<b>T/1650SXCW</b>	SULLY 115W LED compartment with potentiometer - Cool White - 3 meter power cable with CEE 7/7 (2P+T NF/SCHUKO) connector - Poids: 2.27 Kg	
<b>T/1650SXWW</b>	SULLY 115W LED compartment with potentiometer - Warm White - 3 meter power cable with CEE 7/7 (2P+T NF/SCHUKO) connector - Poids: 2.27 Kg	
<b>T/600SX</b>	Lamp compartment for 1000/1200W tungsten GX9,5 lamps - 3 meter power cable with CEE 7/7 (2P+T NF/SCHUKO) connector - Poids: 1.36 Kg	

<b>VD120</b>	120x120mm frosted glass	
<b>Kit TELRAD</b>	Telrad followspot sight with raiser and universal mounting kit - Poids: 1.23 Kg	
<b>SDUP</b>	Followspot cue sheet holder with universal mounting kit	
<b>FC1124/S</b>	Flight-case for Ultra Compact range / GT stand - Poids: 35 Kg	
<b>W/GT800</b>	Set of 3 wheels for GT800/1000 stand - Poids: 2.33 Kg	